

## **gland packing division**



- **PUMP PACKING**
- **VALVE PACKING**
- **LIFE LOADING**
- **THROAT BUSHING**
- **AUXILIARY MAINTENANCE EQUIPMENT**
- **FLOWMETERS**
- **BEARING PROTECTION**

## Introduction



AESSEAL plc Group Headquarters, Rotherham, UK.

AESSEAL® is a world leader in sealing technology. AESSEAL® manufactures and supplies possibly the world's largest range of mechanical seals, supported by international service centres. To complement this range AESSEAL® also manufactures an extensive range of high quality gland packing. In our opinion, this outstanding range of products and services make AESSEAL® the best choice whatever your seal or packing requirements may be.

The company is fully committed to excellence in customer service and this commitment runs through the organisation at all levels. Exceptional customer service is only possible if the entire organisation lives and breathes it.

- One global delivery performance standard
- In our industry; **inventory = service**
- AESSEAL® packing division holds extensive inventory so customers have no need to do so; probably the highest level of inventory to sales value in the industry, with a strategic inventory turn of over 3 times

### Proven Maintenance Costs Reductions

AESSEAL® offers a selected range of gland packing that have been specifically designed and manufactured to reduce plant operational maintenance costs. The cost of packing is low when compared to the cost of down time of a plant incorporating machinery wear, product loss, gland maintenance and labour. Therefore, it is of the utmost importance to select the highest quality modern fibre packing in an inter-braided construction and optimised profiles to provide the most resilient, long-lasting packing sealing solution.

### Proven Quality and Reliability

AESSEAL® provides a complete packing service, combining extensive stock holding and expert technical advice, based on over 20 years of experience. AESSEAL® packing utilises the most advanced and enduring inter-braid construction.

### Maximum Service Life and Resilience

The braiding quality is of prime importance, otherwise it could significantly affect the service life. Any packing that is manufactured using smaller or obsolete braiding machines lack the strength of real cross-lock construction, because they are more rounded in cross-section and not as dense.

If the packing braid is loose, it will be less durable. If it is round, a greater gland pressure is required to carry out the sealing process thereby causing higher mechanical stress. As the packing wears out, more and more adjustments are needed to the gland, which in turn causes further mechanical stress on the packing, resulting in reduced life span.

The highest level of packing design is to be found in a **trapezoid shaped construction** as described on pages 11-13 of this publication.

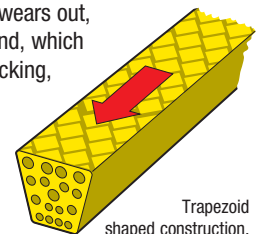

Trapezoid shaped construction.

This test rig allows to measure on each installed packing ring:

- Pressure drop on Outer diameter
- Temperature
- Leakage

In addition energy input and the total leakage on shaft and housing can be determined. A variable speed control allows to simulate the influence of miscellaneous and hydrodynamic friction on the seal ability and the running properties. The efficiency of lantern rings and neck bushes in different positions of the stuffing box can be examined.

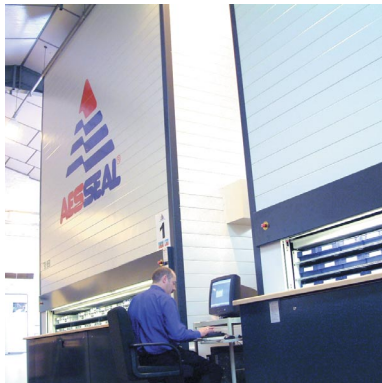

Industry leading service is enhanced by a fully automated stocking and inventory system.



EDI Test rig for Pump packing.

### Maximum Packing Life

Beside its construction, size mostly affects the performance of a packing. Our applied SPC (Statistic Process Control) technology guarantees precision and continuity. Packing that is too big will burn out, and packing that is too small will require permanent adjustment. Inconsistent density and sized packing will never give a controllable packing leakage.

Precision braiding and subsequent treatment fulfil the requirements of an even and parallel surface between the packing rings. SPC further guarantees for a constant quality with repeatable results, which leads to a higher operating reliability and prolonged service life expectancy for the user. Packing that bears the SPC Quality Seal is under a permanent control throughout the entire production process. This has the advantage that any discrepancy is immediately detected as a tendency and can be corrected, before it results in size failures or density variations.

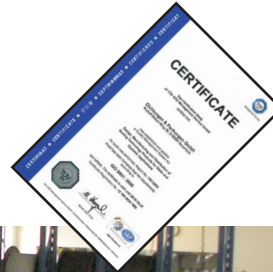

Packing Stock.

AESSEAL® packing displays an exceptional level of resilience and conformity of volume. Their high quality design and construction requires less pressure on the gland to form the seal, which leads to less wear on the equipment, less maintenance and most importantly, increased packing life span. The advanced technological developments of the newer synthetic fibres, together with the braid construction, allow packing to be manufactured which give a superior performance. The synthetic fibre packing is far more cost effective and greatly reduces operational costs, which are the most important factors when considering gland packing selection.



Braiding Hall.

Engineered products like die formed or pre-cut rings, rectangular shapes, seal frames etc. delivered for individual customer applications account for over 35% of AESSEAL® packing division total sales. Of the turnover, 65% are standard products and come with 24 hour shipment availability from our extensive stock. AESSEAL® has a dedicated packing division that provides instant customer support for non-standard requirements.

In addition to the focused technical application team, the rapid delivery philosophy and the seamless equipped braiding centre processes packing from 2mm (0.063") to 100mm (4.000") cross-section in all kinds of shapes from square, optimised square to Trapezoid, round or rectangular cross-sections.

## Pump Packing

Pump packing is used for high shaft speeds. Pump packing contains specially formulated lubricants to aid on equipment start up and ensure packing pliability for a longer life.

### STYLE 210

100% ParaAramid continuous fibre with PTFE impregnation and a special dynamic 'run-in' lubricant, silicon oil free.

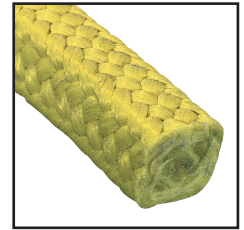

#### Characteristics

- Good for abrasive products, wear resistant, universal packing particularly suited to the sewage and paper industries
- Little monitoring required, short run-in period
- Shaft or shaft sleeve (HRC 60\*) recommended

	☼		☽		⌋		
p [bar]	25	360	500	7,200	250	3,600	p (psi)
v [m/s]	25 (20 <sup>^</sup> )	82	2	6.6	-	-	v (ft/s)
t °C	-50 ... +280 (250 <sup>^</sup> )			-58 ... +555			t °F
pH	2 - 12			2 - 12			pH
g/cm <sup>3</sup>	1.30			0.043			lb/in <sup>3</sup>

### STYLE 274 / 270

Combination braid made of ePTFE/Graphite and ParaAramid Fibre with 'run-in' lubricant.

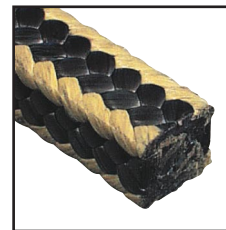

#### Characteristics

- Excellent heat conductivity
- Recommended shaft hardness: HRC 50\*
- Universal packing for abrasive products
- Reduced adjustment work
- STYLE 274 with corner reinforcement for reciprocating movement or for equipment with bigger clearances

	☼		☽		⌋		
p [bar]	25 (20 <sup>^</sup> )	360	500	7,200	250	3,600	p (psi)
v [m/s]	20	66	3	9.8	-	-	v (ft/s)
t °C	-100 ... +280 (250 <sup>^</sup> )			-148 ... +555			t °F
pH	2 - 12			2 - 12			pH
g/cm <sup>3</sup>	1.50			0.054			lb/in <sup>3</sup>

#### Also available as:

STYLE 270 in "zebra" braid, running track reinforced for rotating equipment (shown right).

### STYLE 290

Synthetic fibre with PTFE impregnation and silicon free dynamic 'run-in' lubricant.



#### Characteristics

- High durability and flexibility
- Excellent chemical resistance (e.g. hydrofluoric acid 15%/50°C)
- High cross-section density through PTFE blocking agent, good for crystallising media
- Shafts - HRC 35\* minimum hardness
- Good pliability, therefore perfectly adaptive to uneven shaft surfaces

	☼		☽		⌋		
p [bar]	20	360	60	870	100	1,450	p (psi)
v [m/s]	15	41	2	6.6	-	-	v (ft/s)
t °C	-50 ... +280 (250 <sup>^</sup> )			-58 ... +555			t °F
pH	1 - 13			1 - 13			pH
g/cm <sup>3</sup>	1.35			0.049			lb/in <sup>3</sup>

#### Suitable for:

Sugar, paper and chemical industries.

#### Icon Key

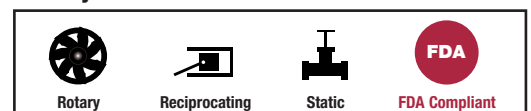



## STYLE 325

Carbon fibre with special Graphite Impregnation and silicone free run in lubricant.

### Characteristics

- Graphitised all-round packing with excellent Emergency run Capabilities
- Good wear resistance against abrasive and crystallizing products
- Volume stable, pressure stable
- High Cross section density due to special impregnation
- Excellent Value for money
- Recommended shaft Hardness HRC 45 Suitable for: Chemical and Paper Industries, Sewage treatment plants, community facilities



				
p [bar]	25 (20 <sup>^</sup> ) 360	100 1,450	100 1,450	p (psi)
v [m/s]	20 66	2 6.6	- -	v (ft/s)
t °C	-50 ... +250		-58 ... +482	
pH	2 - 12		2 - 12	
g/cm <sup>3</sup>	1.15		0.042	

### Suitable for:

Chemical and Paper Industries, Sewage treatment plants, community facilities Technical DATA.



## STYLE 330

Highest Grade Carbon fiber impregnated with specially formulated dynamic silicon free run in lubricant.

### Characteristics

- Excellent versatility
- Wear resistant for abrasive products, does not score shafts (HRC 45\* and above recommended)
- Stable volume, no shrinkage, excellent heat conductivity
- Excellent chemical and physical properties
- Suitable as a bullring in combination with softer pliable packing



				
p [bar]	30 (25 <sup>^</sup> ) 435	100 1,450	100 1,450	p (psi)
v [m/s]	25 82	2 6.6	- -	v (ft/s)
t °C	-58 ... +300 (250 <sup>^</sup> )		-58 ... +575	
pH	2 - 12		2 - 12	
g/cm <sup>3</sup>	1.45		0.052	



## STYLE 550 / 560

Synthetic Fibre, PTFE impregnated with 'run-in' lubricant.

### Characteristics

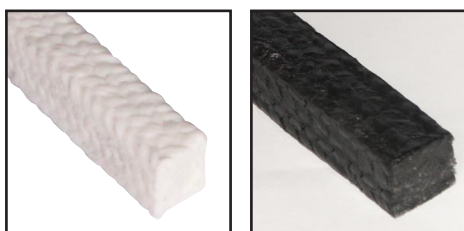
- Protected against wear with abrasive media
- Cross-section density and structural stability, nevertheless elastic and pliable
- Recommended shaft hardness: HRC 50\*
- Simple handling during installation and run-in period
- Cost effective packing



				
p [bar]	20 290	200 2900	250 3,600	p (psi)
v [m/s]	10 33	2 6.6	- -	v (ft/s)
t °C	-100 ... +200 (140 <sup>^</sup> )		-148 ... +390	
pH	3 - 12		3 - 12	
g/cm <sup>3</sup>	1.35		0.049	

### Suitable for:

Paper and pulp industries, sugar plants, waste water treatment.

### Also available as:

STYLE 560 graphitised with improved heat conductivity (shown right)

## Pump Packing

Pump packing is used for high shaft speeds. Pump packing contains specially formulated lubricants to aid on equipment start up and ensure packing pliability for a longer life.

### STYLE 790

PTFE-Graphite Multifilament Fiber with silicone free 'run-in' lubricant.

#### Characteristics

- Self-lubricating, graphite enhanced to give minimal friction and good heat conductivity
- Short run-in period
- Shaft protective (HRC 25\*)
- Resistant against extrusion
- Universal packing, good price/performance ratio



	☉		☽		☼		
p [bar]	25 (20*)	360	250	3,600	100	1,450	p (psi)
v [m/s]	20	66	2	6.6	-	-	v (ft/s)
t °C	-50 ... +280 (180^)				-58 ... +555		t °F
pH	0 - 14				0 - 14		pH
g/cm³	1.70				0.061		lb/in³

### STYLE 799

Braid of EPG fiber ePTFE with incorporated Graphite and silicone run in lubricant.

#### Characteristics

- Good heat conductivity
- Protection against shaft wear (HRC 25 is sufficient)
- Highly efficient cost - value ratio
- Easy installation and handling
- No ageing process



	☉		☽		☼		
p [bar]	20	290	200	2,900	100	1,450	p (psi)
v [m/s]	20	66	2	6.6	-	-	v (ft/s)
t °C	-50 ... +280 (180^)				-58 ... +555		t °F
pH	0 - 14				0 - 14		pH
g/cm³	1.45				0.052		lb/in³

#### Suitable for:

Universal use, sewage, acids, solvents, oil and grease.

### STYLE 870

Ramie fibre with PTFE blocking agent and silicone free run in lubricant.

#### Characteristics

- Universal packing for lower temperatures
- Cost effective
- Long lasting, shaft protecting, resistant to rotting.
- Good for media containing solids
- Recommended shaft hardness: HRC 45\*

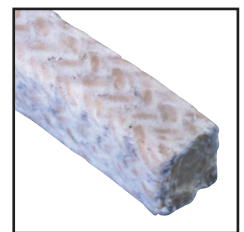

	☉		☽		☼		
p [bar]	25 (15*)	360	100	1,450	100	1,450	p (psi)
v [m/s]	12	39	1.5	9.8	-	-	v (ft/s)
t °C	-50 ... +140 (120^)				-58 ... +285		t °F
pH	4 - 11				2 - 12		pH
g/cm³	1.45				0.052		lb/in³

## STYLE 785

Braided from 100% Gore® GFO® expanded PTFE-fibre with incorporated graphite and silicone run in lubricant.

### Characteristics

- Made from 100% GORE® GFO® fibre
- Highly thermally conductive
- PTFE and graphite is fixed closely together by an incorporation process and treated with a break in lubricant capable of withstanding high temperatures
- Effectively chemically inert over the entire pH range and particularly suitable in arduous chemical applications
- Produced using our dense cross-lock process for square inter-braiding. Helps prevent extrusion problems, reduces gland pressure needed and prolongs packing life
- Shaft protective (HRC 25\*)



	●		■		⏏		
p [bar]	25	360	250	3,600	150	2,200	p (psi)
v [m/s]	25	82	2	6.6	-	-	v (ft/s)
t °C	-100 ... +280 (200 <sup>^</sup> )			-148 ... +555			t °F
pH	0 - 14			0 - 14			pH
g/cm <sup>3</sup>	1.55			0.056			lb/in <sup>3</sup>

## GORE® GFO® Packing Fibre – The Profile of a Good Packing!



- long service life
- minimized shaft wear
- universal in use - ideal for standardization
- very good start up - and emergency running characteristics
- non hardening
- near universal chemical resistance

### Why are 100% GORE® GFO® Packing Fibres Unique?

Homogeneous GFO® fibre was specifically developed as a packing yarn with the heat transfer and lubricant components forming an integral fibre.

In contrast, conventional packing yarns require these components to be added as a coating during service of the packing.

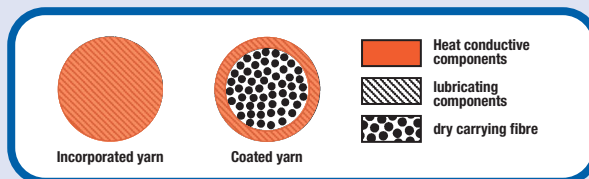
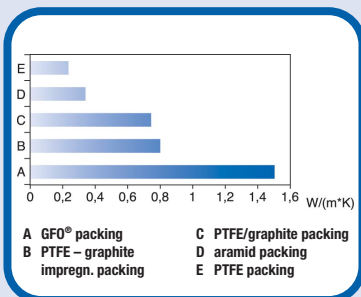

**Excellent Heat Conductivity** 100% GFO® fibre packing is the material with the highest thermal conductivity. Only a high thermal conductive packing like GORE® GFO® Packing Fibre is able to ensure minimum leakage. Especially in high temperature or high speed applications the thermal conductivity is essential. While other materials would harden, dry out or even burn, GORE® GFO® Packing Fibres will run with minimum leakage.



W.L. Gore & Associates GmbH  
Wernher-von-Braun-Str. 18  
D - 85640 Putzbrunn

E-Mail: sealants\_EU@wlgore.com  
Tel. +49 / 89 / 46 12 - 22 15  
Fax +49 / 89 / 46 12 - 23 06

GORE-GFO® und GFO® sind eingetragene Marken der  
W.L. Gore & Associates, © W.L. Gore & Associates GmbH.2010

GORE®, GFO and designs are trademarks of W. L. Gore & Associates GmbH

## Special Packing

These packings use fibres and braiding processes specifically developed to suit the field of application. The formulation of the materials and lubricant is selected to suit the environment in which the packing is used.

### STYLE 260

Combi-braid of PTFE-fibre with ParaAramid corner reinforcement and 'run-in' lubricant.

#### Characteristics

- High cross-section density and compactness
- Elastic and flexible
- Also usable in pumps
- Recommended shaft hardness: HRC 55\*
- Universal quality for high pressure applications and use with abrasive media
- No contamination of media
- Wear resistant and form stable

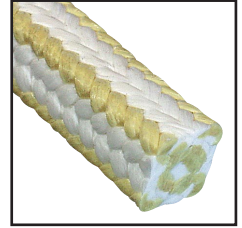

	●		■		⌄		
p [bar]	25 (20 <sup>^</sup> )	360	500	7,200	250	3,600	p (psi)
v [m/s]	20 (15 <sup>^</sup> )	66	2	6.6	-	-	v (ft/s)
t °C	-100 ... +280 (200 <sup>^</sup> )			-148 ... +555			t °F
pH	2 - 12			2 - 12			pH
g/cm <sup>3</sup>	1.45			0.052			lb/in <sup>3</sup>

### STYLE 720

PTFE-fibre with PTFE dispersion and silicone free run in lubricant.

#### Characteristics

- Pliable, easy to compress packing
- Minimum surface hardness (HRC 25\*)
- Good emergency running properties
- Excellent chemical resistance

Clean packing should be used where contamination of product has to be avoided.



	●		■		⌄		
p [bar]	15 (10 <sup>^</sup> )	220	100	1,450	100	1,450	p (psi)
v [m/s]	10 (8 <sup>^</sup> )	33	1.5	4.9	-	-	v (ft/s)
t °C	-50 ... +280 (200 <sup>^</sup> )			-58 ... +555			t °F
pH	0 - 14			0 - 14			pH
g/cm <sup>3</sup>	1.70			0.061			lb/in <sup>3</sup>

STYLE 725 SI and 727PA are made from special fibers and lubricants and are therefore FDA compliant

**FDA**

FDA Compliant

### STYLE 760

100% GORE G2 Fibre. PTFE-fibre with incorporated graphite.

#### Characteristics

- Very stable shape, little wear
- Good heat conductivity
- Can be used as a bullring
- Minimum surface hardness (HRC 25\*)
- Recommended for HIGH PRESSURE applications in valves and piston pumps
- Suitable for oxygen bleaching operations

**BAM approval for oxygen in liquid and gas form at 65 bar/40°C and 50 bar/200°C (945 psi/105°F and 725 psi/390°F.**



	●		■		⌄		
p [bar]	40	580	800	11,600	500	7,200	p (psi)
v [m/s]	8	26	3	9.8	-	-	v (ft/s)
t °C	-200 ... +280 (200 <sup>^</sup> )			-333 ... +555			t °F
pH	0 - 14			0 - 14			pH
g/cm <sup>3</sup>	1.35			0.049			lb/in <sup>3</sup>



Valve packing is generally used in high pressure applications. The packing contains no extractable materials such as oil and remains non-porous even under extreme temperatures. The construction has a fine surface texture to make it pliable against the valve stem and is by design very extrusion resistant.



## STYLE 310

Carbon-filament yarn with high temperature graphite impregnation.

### Characteristics

- The high temperature graphite impregnation raises the cross-section density and acts as a stable pressure cushion for the carbon fibres
- Elastic, doesn't wear and offers valve stem protection
- Very good with temperature changes as carbon and steel have a similar thermal expansion coefficient
- Excellent suitability for bullrings (anti-extrusion rings) in combination with expanded graphite packing like STYLE 350



						
p [bar]	30	435	-	-	300 4,350	p (psi)
v [m/s]	15	82	-	-	-	v (ft/s)
t °C	-40 ... +450 (550 steam)		-40 ... +1,000			t °F
pH	2 - 12		2 - 12			pH
g/cm <sup>3</sup>	1.10		0.039			lb/in <sup>3</sup>



## STYLE 340

Braid made of flexible expanded natural graphite foil with a 10 myh wire mesh reinforcement per braiding strand.

### Characteristics

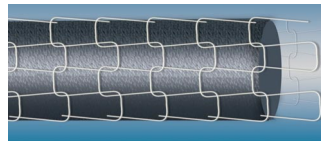
- Highest quality pure graphite gives a coefficient of expansion similar to steel
- High Extrusion resistance, can be used as bullring for STYLE 335, 350 and 355
- Excellent disassembly due to wire reinforcement compared to standard expanded Graphite rings
- Packing needs to be compressed to a level of 1.4 to 1.6 density during the assembly
- Universal valve packing
- Non hardening
- Die formed rings are recommended



						
p [bar]	-	-	-	-	500 7,200	p (psi)
v [m/s]	-	-	-	-	-	v (ft/s)
t °C	-200 ... +450 (650 steam)		-330 ... +1200			t °F
pH	1 - 14		1 - 14			pH
g/cm <sup>3</sup>	1.15		0.042			lb/in <sup>3</sup>

**NOT TO BE USED in rotating application!**



## STYLE 350

Braid made of flexible expanded natural graphite foil.

### Characteristics

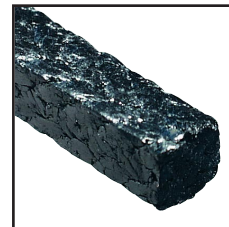
- Very good emergency running capability, no wear on the shaft, excellent thermal conductivity
- Highest quality pure graphite gives a coefficient of expansion similar to steel
- The rings have to be pre-compressed at a level of 1.3 to 1.5 during the assembly
- Can be universally applied
- Packing needs to be pre-compressed
- Die formed rings are recommended



						
p [bar]	20	290	-	-	300 4,400	p (psi)
v [m/s]	20	66	-	-	-	v (ft/s)
t °C	-200 ... +400 (550 steam)		-330 ... +750 (1000)			t °F
pH	0 - 14		0 - 14			pH
g/cm <sup>3</sup>	1.20		0.043			lb/in <sup>3</sup>

**STYLE 335** same as STYLE 350 but made from expanded graphite with integrated carbon reinforcement for easier handling.



## STYLE 355

Braid made of flexible expanded natural graphite foil with an integrated inconel reinforcement per fiber strand.

### Characteristics

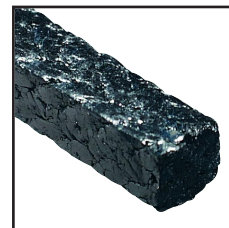
- Highest quality pure graphite gives a coefficient of expansion similar to steel
- Improved disassembly compared to standard expanded Graphite rings
- Can be universally applied
- Packing needs to be pre-compressed to a level of 1.4 to 1.6 density during the assembly
- Non hardening
- Die formed rings are recommended



						
p [bar]	-	-	-	-	300 4,400	p (psi)
v [m/s]	-	-	-	-	-	v (ft/s)
t °C	-200 ... +400 (550 steam)		-330 ... +750			t °F
pH	0 - 14		0 - 14			pH
g/cm <sup>3</sup>	1.25		0.045			lb/in <sup>3</sup>

**NOT TO BE USED in rotating application!**

## Valve Packing

### STYLE 375

Highest grade Graphite Filament yarn with High temperature Graphite impregnation.

#### Characteristics

- Works perfect as bullring for softer packing made of expanded graphite
- The high temperature Graphite impregnation increases the cross section density and works as a form stable pressure cushion for the graphite fibre
- Purity > 99% C content
- Universal chemical resistance
- Excellent in Temperature changes, since graphite has a similar coefficient of expansion as steel



	●		■		⏚		
p [bar]	30	435	-	-	300	4,350	p (psi)
v [m/s]	20	60	-	-	-	-	v (ft/s)
t °C	-40 ... +500 (650 steam)		-40 ... +950 (1200)				t °F
pH	0 - 14		0 - 14				pH
g/cm³	1.10		0.039				lb/in³

#### Suitable for:

Power plants, Boiler houses, high pressure- and high temperature applications, Digester Application

**BAM approval for the use in gaseous and liquid oxygen @ 60°C/15bar / 140°F/218 psi**

### STYLE 730

100% PTFE-fibre with special PTFE dispersion.

#### Characteristics

- For high pressure applications and vacuum respectively, die formed rings are recommended
- Long operational period, does not wear
- Very little maintenance, few adjustments necessary
- Universal chemical use
- Lowest coefficient of friction



	●		■		⏚		
p [bar]	25	360	250	3,600	500	7,200	p (psi)
v [m/s]	2	6.6	1.5	4.9	-	-	v (ft/s)
t °C	-200 ... +280		-330 ... +555				t °F
pH	0 - 14		0 - 14				pH
g/cm³	1.60		0.058				lb/in³

On request, a special version 7350X is available with BAM approval for oxygen in liquid and gas form at 30 bar/60°C (435 psi/140°F). This special packing would also be FDA compliant.

FDA

FDA Compliant

# COMPRESSION PACKINGS

## USING LENZING HIGH PERFORMANCE FIBRES

For some 30 years, packing manufacturers around the world have placed their trust in **LENZING PACKING YARNS**.

**PTFE-yarns** with their thermostability and universal chemical resistance, long service life and excellent cost/performance ratio, are still the # 1 in high-performance packing.

**LENZING-PLASTICS** offers **both highly oriented, white and graphite-layered PTFE filament yarns** for excellent extrusion resistance and dimensional stability as well as **graphite- and talc-filled ePTFE-yarns** offering more resilience and conformability.

Superior packings often use a combination of both filament and expanded

PTFE-yarns - resulting in a packing of graded density and hardness for better leakage control with less wear. Special grades are available for food and drug applications as well as for oxygen service.

New **HYBRID-YARNS** combine the excellent sealability of PTFE with the strength and wear resistance of other high-performance fibres.

A wide range of braider-ready high performance yarns complete our yarn offering.



For further information, please contact:

Lenzing Plastics GmbH  
A-4860 Lenzing, Austria  
Bundesstraße 5a

Phone: +43 (0) 7672 701-2710 or 2689  
Telefax: +43 (0) 7672 918-2710 or 2689

Email: [m.seyrl@lenzing.com](mailto:m.seyrl@lenzing.com)  
Internet: [www.lenzing.com](http://www.lenzing.com)

**lenzing**  
**PTFE**  
**LENZING**  
**PLASTICS**

Normal packing deforms, especially when large cross-section packing is wrapped around a small diameter shaft. The AESSTAR™ range is specially produced with a non-uniform keystone section, which forms the perfect cross-section when installed in the stuffing box. The AESSTAR™ range transforms from a keystone into a square shape, providing an even pressure distribution over the entire stuffing box, avoiding leakage along the outer diameter and minimising the wear of both the shaft and the packing. This extends the life of the packing, improves the sealability and gives shorter run-in periods.

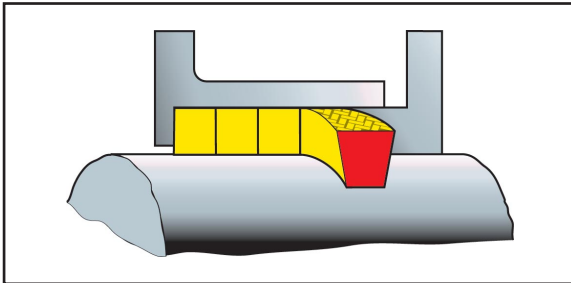

The red arrow stamp on the Outside Diameter of AESSTAR™ packing indicates the Outside Diameter stuffing box bore side of the packing and displays the **preferred installation orientation**. Therefore, it is recommended that the arrow mark point in the direction of rotation of the shaft.

**AESSTAR™ Packing is manufactured in sizes 10mm (0.375") and above. Smaller sizes are manufactured in square cross-section.**

### Trapezoid Advantage

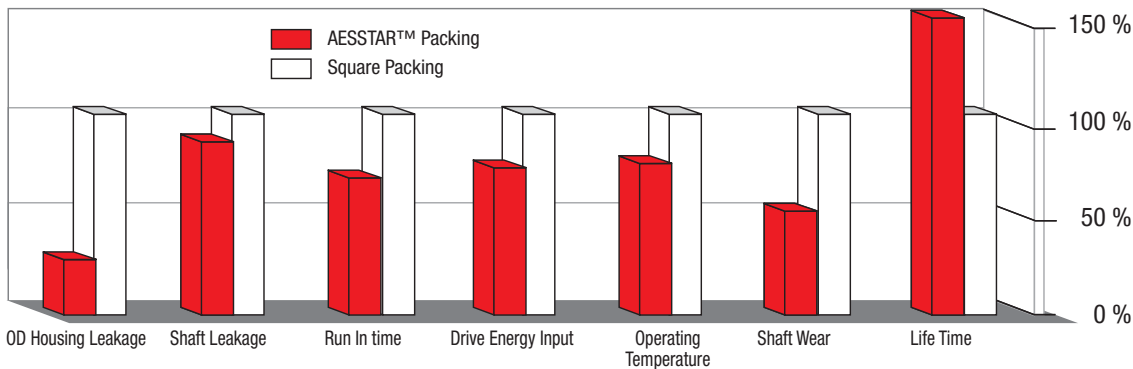

### STYLE 250TP

Aramid staple fibre with PTFE-blocking agent and silicone free 'run-in' lubricant.

#### Characteristics

- Volume stable, pressure stable, also usable for fittings
- Offers excellent wear resistance, suited to abrasive and hardening media
- Dense surface and cross section with high PTFE content and special yarn structure
- High cross-section density, protects against crystallising media
- Recommended shaft hardness: HRC 50\*
- Trapezoid shape for reduced shaftwear

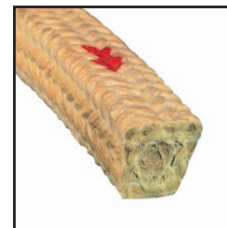

	⊗	⊠	⊡	⊣			
p [bar]	25 (20*)	360	100	1,450	100	1,450	p (psi)
v [m/s]	20	66	2	6.6	-	-	v (ft/s)
t °C	-100 ... +250		-148 ... +480				t °F
pH	2 - 12		2 - 12				pH
g/cm³	1.20		0.043				lb/in³

#### Also available:

In square shape as Style 245 and as Style 240 without run in lubricant in a range of sizes for Valve applications. STYLE 240 SOFT for gate valve applications

### STYLE 266TP

Combination braid of ePTFE Garn with incorporated Graphite and MetaAramid fiber and special pore-filling impregnation

#### Characteristics

- Highest practical Standardisation possibilities
- Equal reduced wear through special Running track reinforcement
- High Cross section density and compactness, still elastic and flexible Good with hardening and crystallizing products
- Special impregnation ensures packing will not harden and improves pliability
- Shaft surface hardness of HRC 35 recommended
- Excellent chemical resistance



	⊗	⊠	⊡	⊣			
p [bar]	25	360	150	2,200	150	2,200	p (psi)
v [m/s]	20	66	2	6.6	-	-	v (ft/s)
t °C	-100 ... +300 (250*)		-148 ... +555				t °F
pH	1 - 13		1 - 13				pH
g/cm³	1.55		0.056				lb/in³

\*HRC = Hardness Rockwell C Scale.

**STYLE 275TP SLURRYSTAR**

Combination braid of expanded PTFE-Graphite and Para-Aramid fibre as corner reinforcement with special pore-filling impregnation.

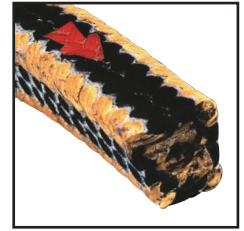

**Characteristics**

- Reinforced packing with reduced wear through improved heat conductivity
- Extrusion resistant, ideal for worn equipment with bigger gap width
- Recommended shaft surface hardness (HRC 50\*)
- Safe universal packing for abrasive media

**Suitable for:**

Paper and pulp, sugar, sewage and chemical industries.

	●		■		⏚		
p [bar]	25	360	500	7,200	250	3,600	p (psi)
v [m/s]	20	66	3	9.8	-	-	v (ft/s)
t °C	-100 ... +280			-148 ... +555			t °F
pH	2 - 12			2 - 12			pH
g/cm³	1.50			0.054			lb/in³

**STYLE 285TP PAPERSTAR**

MetaAramid fibre with PTFE blocking agent and 'run-in' lubricant.



**Characteristics**

- 'Clean packing' required in applications where safety against contamination is required
- High cross-section density and structural stability, but still elastic and flexible
- Minimised friction means reduced shaft wear
- Protected against wear with abrasive media
- Simple handling during installation and run-in period
- Recommended shaft hardness: HRC 45\*

**Suitable for:**

Paper and pulp industries, sugar plants, waste water treatment.

	●		■		⏚		
p [bar]	25 (20 <sup>^</sup> )	360	100	1,450	100	1,450	p (psi)
v [m/s]	20	66	2	6.6	-	-	v (ft/s)
t °C	-100 ... +280 (200 <sup>^</sup> )			-148 ... +555			t °F
pH	1 - 13			1 - 13			pH
g/cm³	1.35			0.049			lb/in³

**STYLE 366TP**

Braided from integrated carbon fiber reinforced expanded graphite fiber with carbon corner reinforcement.

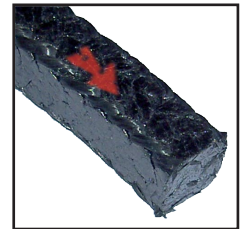
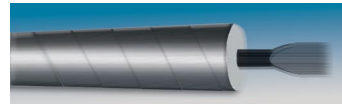

**Characteristics**

- Non-hardening, good reset capability, coefficient of thermal expansion like steel
- Self-lubricating excellent use in pumps, minimising the need of flush water
- Universal plant-wide use in static and rotating applications
- Very good dry running characteristic
- Packing should be compressed to a density of 1.3 to 1.5 during installation We recommend die formed rings
- High temperature resistant, excellent heat and electric conductive
- Wear and extrusion stability through carbon fibre corner reinforcement

**Suitable for:**

Power stations, boiler houses, petrochemical and paper industries. Also available In square shape as Style 365 and without corner reinforcement as Style 335.

	●		■		⏚		
p [bar]	25	360	65	940	300	4,350	p (psi)
v [m/s]	30	100	2	6.6	-	-	v (ft/s)
t °C	-200 ... +400 (550 steam)			-330 ... +750			t °F
pH	0 - 14			1 - 13			pH
g/cm³	1.1			0.039			lb/in³

**STYLE 380TP**

High purity Carbonfiber with cross section impregnation and run in lubricant.

**Characteristics**

- Self lubricating fibre with high Carbon content and excellent heat transfer
- Cross section impregnation avoids the penetration of crystallizing products
- Wear resistant against abrasive products, Shaft surface hardness of HRC 45 recommended.
- Excellent Standardisation factor
- Thermal balanced construction, the coefficient of expansion is similar to steel, the packing is volume stable and does not shrink. Therefore minimal adjustment needed

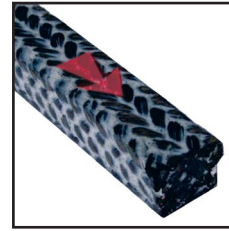

	●		■		⏏		
p [bar]	30	435	100	1,450	100	1,450	p (psi)
v [m/s]	25	82	2	6.6	-	-	v (ft/s)
t °C	-50 ... +300 (250 <sup>^</sup> )				-58 ... +575		t °F
pH	2 - 12				2 - 12		pH
g/cm <sup>3</sup>	1.45				0.052		lb/in <sup>3</sup>

**Suitable for:** Sugar Mills, Pulp and Paper application

**STYLE 745TP FOODSTAR**

Combination braid of PTFE and ePTFE fiber with incorporated heat conductive Mikroparticles.

**Characteristics**

- 'White packing' means no product contamination
- Wide chemical range of usage
- Increased lifetime due to mechanical resistance and good heat conductivity
- Shaft protecting (HRC 25\*)
- Form stable universal packing, suitable for vacuum



FDA Compliant

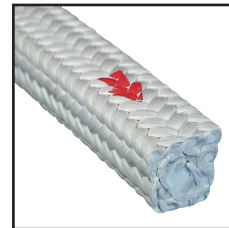

	●		■		⏏		
p [bar]	20	360	100	1,450	100	1,450	p (psi)
v [m/s]	16	52	2	6.6	-	-	v (ft/s)
t °C	-100 ... +280				-148 ... +555		t °F
pH	1 - 14				1 - 14		pH
g/cm <sup>3</sup>	1.7				0.061		lb/in <sup>3</sup>

**Suitable for:**

Pharmaceutical, chemical, pulp and paper, food industries.

**STYLE 770TP PULPSTAR**

Combination braid of expanded PTFE-Graphite and PTFE fibre with special pore-filling impregnation.

**Characteristics**

- High cross-section density and structural consistency, elasticity and adaptability
- Excellent in acidic, alkaline, as well as hardening and crystallising fluids
- A special impregnation prevents hardening of the packing
- Universal Chemical Use
- Improved gliding properties minimising wear
- Shaft hardness HRC 25\* is sufficient

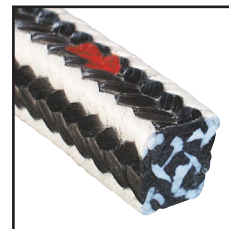

	●		■		⏏		
p [bar]	25	360	250	3,600	250	3,600	p (psi)
v [m/s]	20	66	2	6.6	-	-	v (ft/s)
t °C	-100 ... +280 (200 <sup>^</sup> )				-148 ... +555		t °F
pH	0 - 14				0 - 14		pH
g/cm <sup>3</sup>	1.70				0.061		lb/in <sup>3</sup>

**Suitable for:** Paper and pulp, sugar and chemical industries.

**STYLE 795TP UNISTAR**

Braided from 100% ePTFE-Graphite incorporated fibre with silicone run in lubricant.

**Characteristics**

- Excellent heat conductivity
- Very easy and safe assembly. Also easy to cut and handle
- No embrittlement or ageing and easy to dismantle
- Protects the shaft against wear (HRC 25\*)
- Universal chemical resistance

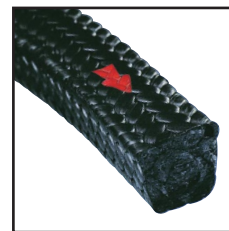

	●		■		⏏		
p [bar]	25	360	250	3,600	100	1,450	p (psi)
v [m/s]	25	82	2	6.6	-	-	v (ft/s)
t °C	-100 ... +280 (200 <sup>^</sup> )				-148 ... +555		t °F
pH	0 - 14				0 - 14		pH
g/cm <sup>3</sup>	1.55				0.056		lb/in <sup>3</sup>

**Available in Square Braid:**

**STYLE 787** with similar performance at an economic price level

\*HRC = Hardness Rockwell C Scale. ^ Practical usefull application data

## DVS INJECTSTAR

The Packing Compound System was developed for the pulp and paper and the chemical industry and is suitable for the application in mixers, kneaders and similar equipment. Due to its excellent pliability, the DVS System can also be used on worn shaft surfaces. Only the top and bottom rings need to be precise dimensioned.

Due to the special fibres and the suitable lubricant, the Sealing Compound is of universal use. The loose compound will be held in place with a top and bottom ring shaped in a special geometry. Additional Material and Compression is applied by a hydraulic feeding unit. The DVS needs little maintenance only and due to its loose structure, it doesn't wear the shaft surface.

- Simple installation
- Use without barrier fluid
- Maintenance free
- Shaft protecting
- No adjusting of the gland
- Re-pressurise in operation

Unit: Cans 1 kg (2.2 lbs), Hobbok of 15 kg (33 lbs)

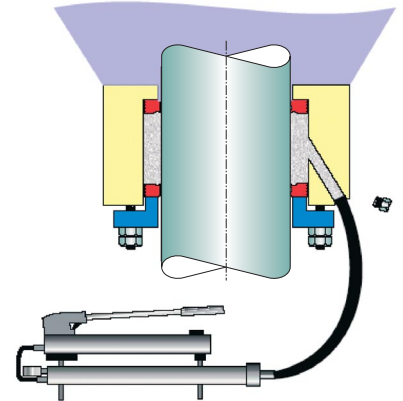

### Technical Parameters DVS-4800

v [m/s]	12	39	v (ft/s)
t °C	-40 ... +315	-40 ... +599	t °F
pH	2 - 12	2 - 12	pH
Colour: Black Application: High temperature			

### Technical Parameters DVS-5400

v [m/s]	8	26	v (ft/s)
t °C	-10 ... +260	+14 ... +520	t °F
pH	2 - 12	2 - 12	pH
Colour: White Application: General use			

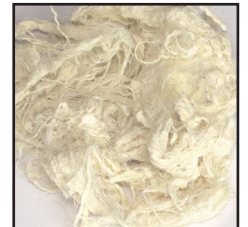

## ENVIROSTAR 200 and 300

Reliability and environmental focused packing solution for valves. TA Luft approved die formed ring assembly including bullrings with some of the lowest emission rates and minimised slip stick effect in automatic driven control valves.

### Characteristics ENVIROSTAR 200:

- This ring set of pure PTFE packing and PTFE compound bullrings, is a high-level technological solution and complies with TA Luft directives. The set was tested and approved by the MPA (Material Proof Institute of the University of Stuttgart, Germany).
- The leakage parameters of  $4.2 \times 10^{-5}$  mbarl/(sm) complies with the VDI directives 2440, which specifies a maximum allowed leakage of  $1.0 \times 10^{-4}$  mbarl/(sm) (test media- helium) and is recommended as a high grade sealing system.

### Characteristics ENVIROSTAR 300:

- This ring set of Carbonfiber with a special High Temperature pore filling Impregnation, is a high-level technological solution and complies with TA Luft directives. The set was tested and approved by the AMTEC Institute Lauffen, Germany.
- The leakage parameters of  $9.8 \times 10^{-3}$  mbarl/(sm) complies with the VDI directives 2440, which specifies a maximum allowed leakage of  $1.0 \times 10^{-2}$  mbarl/(sm) (test media- helium) and is recommended as a high grade sealing system.

### Requirements:

- Max Surface roughness: Shaft: Ra ~ 1 µm Housing: Ra ~ 5 µm
- Gap between shaft/housing and/or shaft/gland max 0.2mm (0.008")
- Pre-compression after installation: 50 MPa/7,250 psi for short time
- Minimum compression in service: 30 MPa/4,350 psi

**THESE TESTS HAVE BEEN SUCCESSFULLY PASSED WITHOUT LIFELOADING. Nevertheless for highest performance and maximum sealing lifetime, we recommend for pressure above 40 bar/580 psi and frequently varying temperature and pressure, the use of LIFESTAR our Lifeloading system (See page 17).**



MPA Approved



AMTEC Approved



## Die Formed Ring Packing

Custom made ring sets for pumps, agitators, valves and reciprocating equipment.

Die formed and pre-cut rings are today's user-friendly solution and at the same time provide the best seal result without product waste.

The assembly is unproblematic and secure. A quality tool stock of over 2,000 die forms in various sizes enable us to fulfil the demands of most of the users of pump and valve packing in quick seal sets.

All styles of our packing program can be made as pre-cut or pre-compressed, die formed rings. The advantages include:

- 1. Technical Improvement:** Packing is already close to its working density. The ring stack has a uniform density throughout the stuffing box length, no over compression of rings next to gland.
- 2. Reduced Inventory:** Excess inventories in packing spools in different size and styles are eliminated by using ring sets dedicated for an application. Common equipment with identical stuffing box sizes and similar application may actually use the same spare part ring set.
- 3. Waste Elimination:** Die formed or pre-cut ring sets eliminate waste created when packing is cut onsite. A ring set has the exact amount of packing rings to pack a pump or valve. Furthermore, no waste occurs when additional packing material of a spool is not returned to stock.
- 4. Faster Installation:** Ring sets reduce repacking time as well as the start up time, and minimise the amount of readjustments.
- 5. Reduced Mis-application:** Dedicated to an application all ring sets can be labelled as spare part for equipment.
- 6. Tracking:** Ring sets as a spare part for any equipment can be performance tracked with our Asset Health program.

To easily identify a dedicated packing ring set for an application, customer stock ring sets can be custom labelled by style, size, number of rings, stores codes, barcodes and other information on request. Our software selects from over 2,000 quality dies the right one for an application and converts from inch to metric sizes.

### Best Technical Solution

#### Design:

- Made of all common types of packing
- Rings or tubes, open, closed or glued ends

#### Form of Delivery:

- Pre-compressed or form cut rings, complete sets
- Available dimensions: 2.5mm (0.079") to 500mm (19.700")
- Custom made constructions on request following drawing details

#### Advantages of Die Formed Packing Rings:

- Better sealing effect - longer service life
- Faster and easier installation - error prevention
- Perfect cut - elimination of waste
- Even pressure distribution - shorter run-in process
- Minimised energy loss due to reduced friction



SOOTSTAR



SCANSET

Special Literature for designed Ringsets for applications is available on request.



#### Controlled Leakage path through ring cuts with additional length

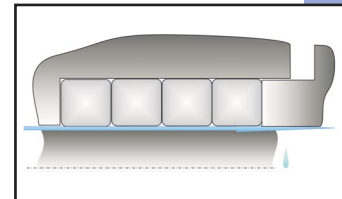
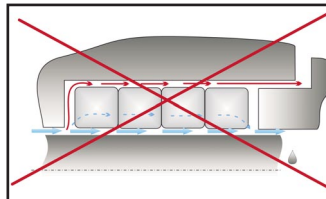

#### Optimised pressure distribution with die formed rings

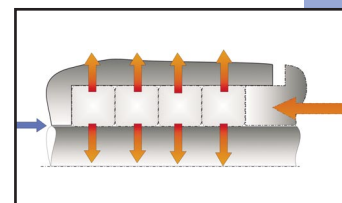
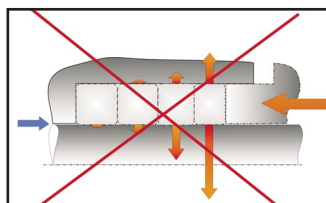

Select from over 2,000 die forms the best solution for your application.



Die Forming Press.

## PFR-THROAT BUSHING

- O-Rings seal to Stuffing box reducing OD leakage
- Keeps particles away from stuffing box area
- Reduce friction which minimize HP losses via packing drag
- Packing runs cooler, which supports reduced water flow requirements
- Centers and Stabilises Shaft
- Minimises Flush water up to 80% by reducing clearances
- Reduction of packing rings results in much less compression on gland
- Use less and softer Packing

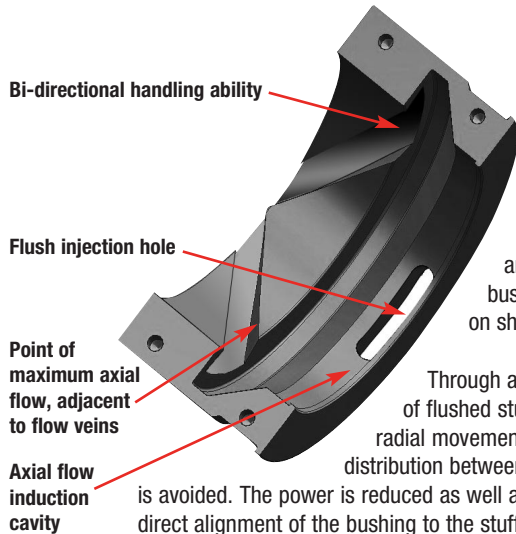
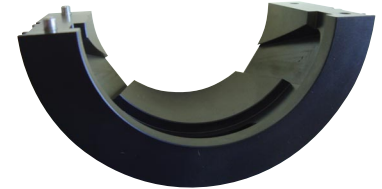

### Features - Benefits:

PFR-Throat bushing for stuffing boxes and flush water management. This throat bushing with spiral grooves and a special flow geometry reduces flush water usage and prevents solids from entering the stuffing box. Produced from a high strength compound which offers excellent running properties and universal chemical resistance. The System uses the displacement and flow orientation around a rotating shaft. In grooves, solids which get between the shaft and bushing, will be collected and expelled by the induced flush stream. It reduces wear on shaft and packing surfaces. As a result softer wearing packing styles can be used.

Through a narrow gap to the shaft, the bushing can be utilized for the water management of flushed stuffing boxes. The PFR-throat bushing centers the shaft hydro-dynamically against radial movement and reduces the stuffing box depth. The result is an equalized compression distribution between the packing rings. An overload on the packing ring next to the packing follower is avoided. The power is reduced as well and the created frictional heat is reduced through the fewer amount of rings. The direct alignment of the bushing to the stuffing box bottom eliminates the risk to move away from the entry flush water port. This is known from the classic lantern rings positioned in the middle of the stuffing box following wear of the product next packing rings.

Higher flush efficiency through the double conical groove's design helps to induce a flush stream and improves the cleaning effect towards the product side. Small amounts of flush water are better utilized. It establishes a cooling effect in the running area of the bushing. The bushing seals the flush flow to the outer diameter. This minimizes the outer diameter leakage and improves the efficiency of the flush fluid and minimizes the flush water amount. The PFR-throat bushing is radially divided for easy installation and has extraction loops. The loops can be hooked over the stuffing box studs for disassembly of the bushing. This allows for the bushing to be pulled out in an equal fashion if it has to be removed.

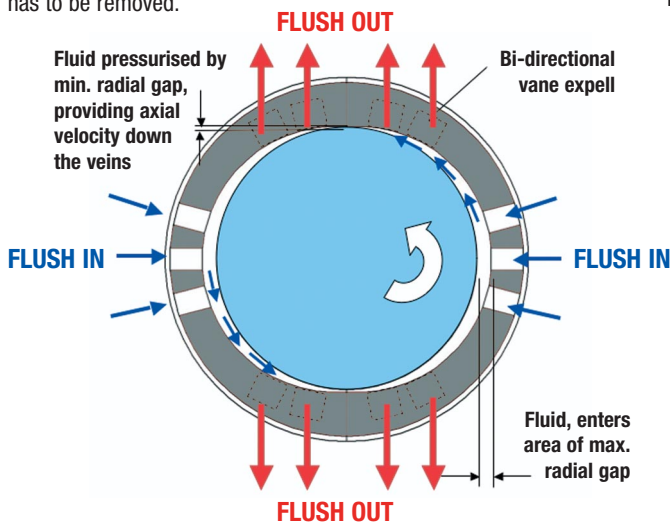
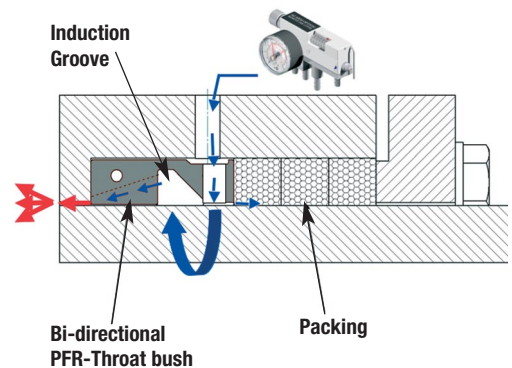



New generation encapsulated disc spring system with defined compression length.

### Main areas of application:

- Valves
- Control Valves
- Sootblowers

### Advantages:

- Disc springs slide on an even machined surface rather than on the bolt thread
- Disc springs are encapsulated by an outer cylinder against environmental impact
- Disc springs never get over-compressed
- No torque measuring tools necessary
- Relaxation of the spring set by volume loss or wear of the packing stack will show on an inspection gap. Simply tighten the nut until the gap closes
- BES-LL acts as a prevention against mechanical destruction of packing keeping it all times under compression
- Extended nut screws on the existing valve bolt and eliminates the need for new longer bolts

### Typical Problem:

The stack of disc springs is too long for the available bolt length. As a result the bolts need to be replaced which is time and cost consuming.

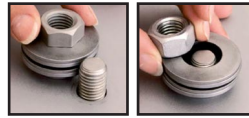

### The Solution:

The BES Lifeloading system screws on top of the bolt in a kind of cup form and gives thereby plenty of extra length to accommodate the uncompressed disc spring stack. This incorporates also an equal load of compression for thermal expansion. The springs cannot be over-compressed as the optimum compression length is set by the BES housing dimension. A side effect of the system is that the disc springs slide instead on a thread on a smooth machined surface. Further, they are encapsulated and protected against dirt and environmental impact.



### Functional Description:

When the packing settles in operation, the springs maintain the gland pressure and the sealing force constant. The settling is shown by a small inspection gap at the bottom of the housing. At a routine inspection, the BES System is simply torqued down until the gap is closed. The full load and compensation length of the disc springs is now available. No torque measuring tools are needed!

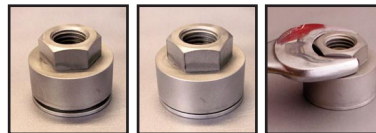

### Dimensional Data

M in (mm)	Order Type	D in (mm)	D in (Inch)	H in (mm)	H in (Inch)	h1 in (mm)	h1 in (Inch)	SW	s in (mm)	M in (Inch)	Order Type	Center Bolt to valve housing min (mm)	Center Bolt to valve housing min (Inch)	FE (kN)	ME (Nm)
M8	L8	22	0.87	16	0.63	12	0.47	14	16.1	5/16	L5/16	15	0.59	0.65	2
M8	L8LO	22	0.87	20.3	0.80	14.5	0.57	14	16.1	5/16	L5/16LO	15	0.59	2.9	9
M10	L10	26	1.02	18.2	0.72	11.2	0.44	17	19.6	3/8	L3/8	18	0.71	1.95	6
M10	L10LO	26	1.02	23.2	0.91	16.1	0.63	17	19.6	3/8	L3/8LO	18	0.71	2.9	9
M10	L10XXLO	26	1.02	30.8	1.21	23.5	0.93	17	19.6	3/8	L3/8XXLO	18	0.71	5.2	16
M12	L12	32	1.26	25.5	1.00	17.5	0.69	19	21.9	1/2, 7/16	L7/16 o. L1/2	22	0.87	5.4	20
M12	L12LO	32	1.26	33.5	1.32	25.5	1.00	19	21.9	1/2, 7/16	L7/16LO o. L1/2LO	22	0.87	9.5	35
M14	L14	38	1.50	28.5	1.12	18	0.71	22	25.3	9/16	L9/16	26	1.02	9.9	48
M14	L14LO	38	1.50	36.5	1.44	26	1.02	22	25.3	9/16	L9/16LO	26	1.02	17.8	85
M16	L16	38	1.50	28.5	1.12	18	0.71	24	27.6	5/8	L5/8	27	1.06	9.9	48
M16	L16LO	38	1.50	36.5	1.44	26	1.02	24	27.6	5/8	L5/8LO	27	1.06	17.8	85
M18	L18	45	1.77	54	2.13	41	1.61	27	31.1	11/16	L11/16	31.5	1.24	22.8	136
M18	L18LO	45	1.77	61	2.40	49	1.93	27	31.1	11/16	L11/16LO	31.5	1.24	28.4	170
M20	L20	45	1.77	54	2.13	41	1.61	30	34.5	3/4	L3/4	32.5	1.28	22.8	136
M20	L20LO	45	1.77	62	2.44	49	1.93	30	34.5	3/4	L3/4LO	32.5	1.28	28.4	170

The AESSEAL® FLOWTRUE™ is a fully patented flow control device. The product range is specifically designed to allow the FLOWTRUE™ to be used with packed glands and single/double mechanical seals. The device reduces the amount of water necessary to lubricate and cool the seal. This reliable seal cooling protects valuable equipment, increases plant uptime and significantly reduces plant water costs.

## MODEL FT-XX: For use with packed glands and single seals

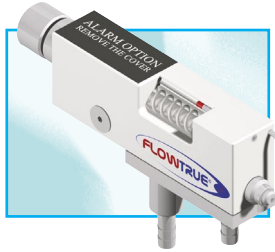

### Flow Ranges (XX):

l/min	gpm
0.5 – 1.5	0.1 – 0.4
0.5 – 3.0	0.2 – 0.8
1.0 – 8.0	0.25 – 2.0
2.0 – 15	1.0 – 4.0

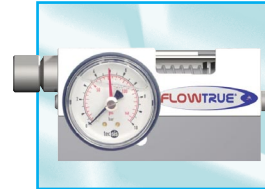

All FLOWTRUE™ models are available as screw connection versions (SC-shown left) as well as the push-on connection versions.

## MODEL FTP-XX-YYY: For use with packed glands and mechanical seals

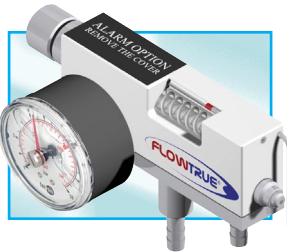

### Flow Ranges (XX):

l/min	gpm
0.5 – 1.5	0.1 – 0.4
0.5 – 3.0	0.2 – 0.8
1.0 – 8.0	0.25 – 2.0
2.0 – 15	1.0 – 4.0

### Pressure Options (YYY):

bar	psi
0 – 10	0 – 145
0 – 25	0 – 360

For pump packing it is essential that a small and controlled leakage occurs on a permanent basis. This lubricates the packing and as a second effect removes frictional heat, which occurs between the packing and the rotating shaft. Modern heat conductive packing can run much drier than old fashioned packing material.

Nevertheless, these new generation styles still need some leakage which may hit towards the pump bearing and once entering the bearing chamber may significantly reduce the equipment operational time. As leakage is necessary for packing, it is not necessary to accept reduced bearing life. AESSEAL® offers world leading bearing protection technology allowing packing to be used more successfully than in the past.

## LabTecta™ Bearing Protector

### Operating Envelope

The LabTecta™ is a non-contacting, while rotating, bearing seal that is designed for use in oil splash, dry running and grease applications on pieces of horizontal equipment.

The LabTecta™ can also be used in the vast majority of existing oil mist applications that comply with the now superseded API 610 7th Edition requirements and where a small quantity of oil mist escapes to atmosphere.

For a face seal compliant with the modern API 610 8th, 9th and 10th Edition 'closed loop' oil mist requirements, please use a MagTecta-OM™.

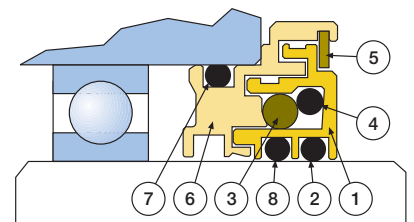

The LabTecta™ is independently certified to IP66, which is the Ingress Protection requirement for IEEE Std 841-2001.

Item	Description	Material
1	LabTecta™ Rotary	Phosphor Bronze
2	Outboard Rotor O Ring	Viton®
3	Arknian™ Shut Off Device	Compound Elastomer
4	Arknian™ Energizer	Viton®
5	Face Shield	Composite Material
6	Stator Housing	Phosphor Bronze
7	Stator Housing O Ring	Viton®
8	Inboard Rotor O Ring	Viton®

- Non-contacting seal ✓
- Ingress protection to IP66 ✓
- Easy to refurbish ✓
- Safe - Non-sparking ✓
- Low cost ✓
- No shaft wear ✓

## AESTEX 100% PTFE Joint Sealant

### Materials:

100% pure e-PTFE (according to VDE-VDI 2480) in a stretched filament knotted fibre structure. This ensures that there is a high pressure resistance (no cold flow) and a good adaptation to the flange surface.

### Characteristics:

- Simple to install, universal plant wide use
- Excellent adaption, ideal to compensate uneven gland surfaces
- Physiologically safe in temperatures up to 260°C/500°F
- Selection criteria: max unevenness of gland should not be greater than 1/3 of **resulting seal thickness**

Order-Nr.	Width (mm)	Width (inches)	Roll length	Recommended Flange width	Surface Pressure / Resulting Thickness		
					10N/mm <sup>2</sup>	20N/mm <sup>2</sup>	30N/mm <sup>2</sup>
AESTEX/1	1	1/24	25m / 82ft	-	0.15	0.10	0.08
AESTEX/3	3 x 1.5	1/8	25m / 82ft	<NW 100/NW 4"	0.40	0.35	0.30
AESTEX/5	5 x 2	3/16	25m / 82ft	<NW 300/NW 12"	0.80	0.60	0.50
AESTEX/7	7 x 2.5	1/4	25m / 82ft	<NW 800/NW 32"	1.00	0.80	0.70
AESTEX/10	10 x 3	3/8	25m / 82ft	<NW 1.500/NW 60"	1.20	0.90	0.80
AESTEX/14	14 x 5	9/16	10m / 33ft	>NW 1.500/NW 60"	1.60	1.20	1.00
AESTEX/17	17 x 6	5/8	10m / 33ft	In case of greater unevenness a double layer is recommended	2.10	1.50	1.40
AESTEX/20	20 x 7	3/4	10m / 33ft		2.40	1.80	1.40
AESTEX/28	28 x 5	1.1	5m / 16.5ft		1.60	1.20	1.00
AESTEX/40	40 x 5	1.5	5m / 16.5ft		1.60	1.20	1.00

Recommended values depending on width and surface Gas tight from 20N/mm<sup>2</sup> surface pressure during operation conditions.

Pressure	[bar]	250	[psi]	3625
Temp min.**	[°C]	-240	[°F]	-400
Temp max.**	[°C]	+270	[°F]	+520
Chem Resist.***	[ph]	0-14		

\*\* After first heat cycle of more than 120°C retighten the bolts.

\*\*\* Except molten or dissolved alkaline metals, elementary or dissolved flourine under high pressure, non ageing.

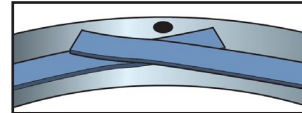

Fig 1

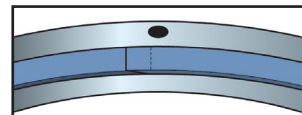

Fig 2



Fig 3



Fig 4

### Installation

1. Clean joint surfaces
2. Detach protection strip from adhesive side
3. Place the seal on the flange
4. Overlap the ends by 1-2 cm right in front of a bolt (Fig. 1)
5. Cut of the rest of seal

For pressure sensitive flanges use a skive cut see Fig. 2 & 5. On big flanges use a concentric layer or meander as in Fig. 3

## AESBIAx 100 % PTFE Flange Gasket Material

Compression Proof and Form Stable e-PTFE Joint Sealant. Main areas of application: larger flanges and vessels, agitators, glaslined flanges and heat exchangers

### Characteristics:

- No change in width during compression, perfect for narrow or limited surface areas

### Material:

100 % pure e-PTFE (in accordance with VDE-VDI 2480) in a biaxial expanded structure.

Width in mm [inch]	Thickness in mm [inch]					
	2 [0.08]	3 [1/8]	4 [0.16]	5 [3/16]	6 [1/4]	9 [0.35]
10 [3/8"]	X	X	X	X	X	X
15 [9/16"]	X	X	X	X	X	X
20 [3/8"]	X	X	X	X	X	X
25 [1"]	X	X	X	X	X	X
30 [1 3/16"]	X	X	X	X	X	X
35 [1 3/8"]	X	X	X	X	X	X
40 [1 9/16"]	X	X	X	X	X	X
45 [1 3/4"]	X	X	X	X	X	X
50 [2"]		X		X	X	X
55 [2 3/16"]		X			X	X
60 [2 3/8"]		X			X	X

### Assembly instruction:

Material ends have to be connected with an approx. 30° angle cut. To seal the cut properly, we recommend to cut slightly longer and overlap the ends to get 120% in material height at the cut in material height.

### General Approvals:

FDA Conformity: CFR 177.1550 – "Perfluorocarbon resins"

Food: According to the German Federal Health Ministry's paper BG Nr. 21 suitable up to 260°C/500°F

### AESTEX

Approvals: TÜV Prüf.-Nr. MP 4/0558 KO x KD= 14,4 x bD N/mm<sup>2</sup> up to 6 bar pressure K1 = 1.63 x bD mm **BAM** Tgb. - Nr. 6895/89 4-2544 for oxygen 100°C 100 bar **DVGW** Reg.-Nr. DG 5127 AU3305 gas and water approved. **TA Luft**: 1.7 x 10 (-7) mbar l/(ms) @ 250°C test pressure Wrc-NSF Ltd

### AESBIAx

Approvals: TÜV Prüf.-Nr. MP 4/0558 KO x KD= 26 x bD N/mm<sup>2</sup> up to 6 bar pressure K1 = 2.4 x bD mm

**TA Luft**: 1.5 x 10 (-8) mbar l/(ms) @ 250°C test pressure

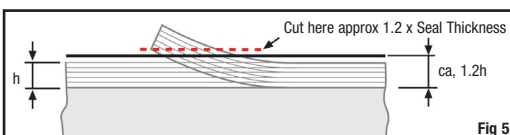

Fig 5

AESBIAx is also available in sheets with the dimension of 1100 x 1000mm and 1500 x 1500mm in thickness of 1mm/0.04" to 9mm / 0.35".



## AQUASTAR

**NEW IMPROVED Cut in place Lantern Ring made of 100% virginal PTFE with FDA conform filler.**

### Characteristics

- Economical storage: independent from shaft diameter, delivered by 1.2m length
- Does not corrode or wear shafts, no tilting effect during assemble and in use
- Replacement for machined metal lantern water rings
- Universal use through excellent chemical and thermal resistance
- Easy to remove with packing extractor

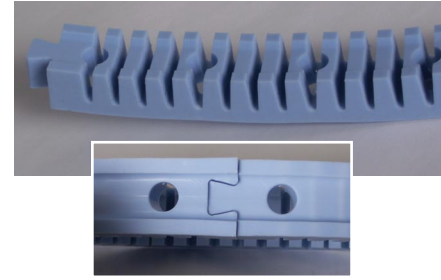

FDA Compliant

### Form of delivery

1200mm (47.000") per roll. Special sizes and length available on request

t °C	-100 ... +250	-148 ... +482	t °F
pH	0 - 14	0 - 14	pH

### Dimensions:

The height of the lantern ring depends on the stuffing box cross-section (see chart below).

Stuffing Box Section	[mm]	7	8	10	12	13	15	16	18	20	22	25
	[inch]	1/4"	5/16"	3/8"	7/16"	1/2"	9/16"	5/8"	11/16"	3/4"	7/8"	1"
Height	[mm]	6.4	7.8	9.4	11.1	12.6	14.2	15.8	17	19	21	23.5
Width	[mm]	9.6	11.4	13.2	15.6	17	19.2	20.6	22.1	23.8	25.2	28.2

## Maintenance Tools

Special auxiliary equipment tailor-made for daily use. Proven quality tools support the quick and reliable installation of all kinds of stuffing box packing.

## Packing Cutter

### Special tool for precise Stuffing Box Packing Cutting

#### Description:

Compact and wear resistant tool made of aluminium. Versions available:



75° Butt cut for pump packing

45° skive cut for valve packing

#### Advantages:

- Packing cut without necessary length calculation (an adder-factor x - is already included)
- Time saving
- Repeatable results
- No waste
- Suitable also for AESSTAR™ packing

#### Technical Data:

- Shaft diameters: up to 110mm (4.330")
- Using extension (accessory: W5/PS-V) up to 250mm (10.000") diameter
- Scale: in inches and mm
- Packing sizes: from 3mm (0.125") to 30mm (1.125")
- Spare parts available

# Packing Extractor

## Construction:

These Packing Extractors have a flexible non-torsion shaft with a tightly bound screw tap nose which is either a sharp screw head or a helical screw head.

## Advantages:

Excellent spot drilling and extracting of old and hardened packings as well as blocked and difficult locations. Special version in other length is available.

## Versions

- Type W2S04 - 4mm sharp screw head with 100mm flexible non-torsion shaft
- Type W2W06 - 5.5mm helical screw head with 100mm flexible non-torsion shaft
- Type W2S06 - 6mm sharp screw head with 160mm flexible non-torsion shaft
- Type W2W08 - 8mm helical screw head with 160mm flexible non-torsion shaft
- Type W2S08 - 8mm sharp screw head with 200mm flexible non-torsion shaft
- Type W2W10 - 10mm helical screw head with 200mm flexible non-torsion shaft
- Type W2S10 - 10mm sharp screw head with 260mm flexible non-torsion shaft
- Type W2W12 - 12mm helical screw head with 260mm flexible non-torsion shaft



Sharp Screw Head W2S



Helical Screw Head W2W

# Packing Selection Database

A new developed database with almost 500 products included, helps to select and specify stuffing box packing for specific applications in pumps and valves. The recommendations are sorted alphabetically by product name. They offer product characteristics and recommendations, as well as possible solutions.

Further sub-programs allow the calculation of packing length, packing weight, ring-cut length and cross-sections for pumps, agitators and valves. In addition and highly recommended in critical applications, our technical department is available for consultation.

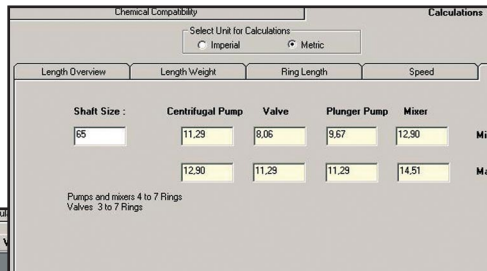

Produkt	Temperatur	Konzentration	Staubklasse
KALUUMBROMID	<25C (77F)	<50%	ALLOY 276
KALIUMCARBONAT	<60 C (140F)	<20%	AISI 316L
KALIUMCHLORID *	<100 C (212F)	<30%	AISI 316L
KALIUMCHROMAT ROT	<100 C (212F)	<55%	AISI 316L
KALIUMCYANID (CYANKALI)	<100 C (212F)	ALL	AISI 316L
KALIUMHYDROXID	<100 C (212F)	>20 <50	ALLOY 400
KALIUMNITRAT	<50 C (114F)	SEE MEMO	AISI 316L
KALIUMSULFAT	<100 C (212F)	SEE MEMO	AISI 316L
KESSELSPEISEWASSER	>150 C (302F)	100%	AISI 316L
KIEFERNOEL (PINE DEL)	<180C (356F)	100%	AISI 316L
KNOCHENFETT	<120C (248F)	100%	AISI 316L
KOHLENMONOXID	<60 C (140F)	100%	AISI 316L
KOHLENDIOXID (FLUESSIG)	SEE MEMO	100%	AISI 316L
KOHLENDIOXID (GAS)	<300C (542F)	ALL	AISI 316L

**STYLE 720**  
PTFE-fiber with PTFE-dispersion and run in lubricant.

**Characteristics**

- Pliable, easy to compress packing.
- Good emergency running properties.
- Excellent chemical resistance.

Clean packing should be used where contamination of product has to be avoided. Available with edge reinforcement (274) for reciprocating applications or as "zebra" braiding (270) for rotating equipment

This software supports the decision finding on the following questions and tasks:

- What kind of packing
- What size cross-section of packing
- Check of surface shaft speed
- Calculate cut length
- Equipment site survey
- Asset health
- Die form tooling check up

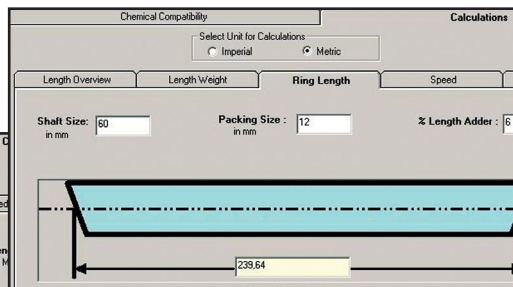
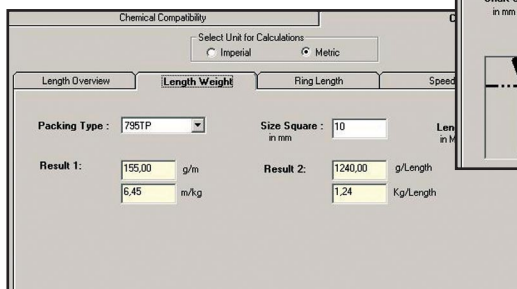

# Technical Parameters

Type	A	A	A	A	A	A	A	A	P	P	P	P	P	P	P	P	S	S		
	310	350	355/340	375	730/7350X	210/250TP	266TP	270	285TP	325	330/380TP	335/366TP	745TP	770TP	785/795TP	790/799	870/550	274/275TP	S	
Material of Construction	Carbon/ Graphite	exp. Graphite	exp. Graphite Inconel/ reinforced	Graphite/ Graphite	PTFE/ PTFE	P-Aramid/ PTFE	M-Aramid/ ePTFE/ Graphite	ePTFE/ Graphite/ Aramid/	M-Aramid/ PTFE	Carbon/ Graphite	Carbon/ PTFE	exp. Graphite/ Carbon	PTEE/ ePTFE/ Heat conductive	ePTFE/ Graphite PTFE	ePTFE/ Graphite	PTFE/ Graphite ePTFE/ Graphite	Ramie/PTFE Synth/PTFE	ePTFE/ Graphite Aramid	PTFE	PTFE/ Lubricant
Density (g/cm3)	1.10	1.20	1.25/1.15	1.10	1.60	1.30/1.20	1.55	1.50	1.35	1.15	1.45	1.0/1.1	1.70	1.7	1.55	1.70/1.45	1.7/1.45	1.50	1.70	1.35
Pressure Rotating [bar]	30	20		30		25	25	20	25	25	30	25	20	25	25	15	15	25	15	40
Speed Rotating [m/s]	15	20		20		20	20	20	20	20	25	30	16	20	25	20	12	20	10	8
Pressure Static p [bar]	300	300	300/500	300	500	100	150	100	100	100	100	300	100	250	100	100	100	250	100	500
Pressure Reciprocating [bar]						100	150	100	100	100	100	65	100	250	250	100	100	500	100	800
Speed Reciprocating [m/s]						2	2	2	2	2	2	2	2	2	2	2	1.5	3	1.5	3
pH	2-12	0-14	1-14	1-14	0-14	2-12	1-13	2-12	1-13	2-12	2-12	0-14	1-14	0-14	0-14	0-14	4-11	2-12	0-14	0-14
Tmin [°C]	-40	-200	-200	-40	-200	-50	-100	-100	-50	-50	-50	-200	-100	-100	-100	-50	-50	-100	-50	-200
Tmax [°C]	+450(550*)	+400(550**)	+450(650*)	+500(650*)	+280	+280/+250	+280	+280	+280	+280	+300	+500(650*)	+280	+280	+280	+280	+140	+280	+280	+280

## PRODUCT COMPATIBILITY

Water	●	●	●	●	●	●	●	●	●	●	●	●	●	●	●	●	●	●	●	●	●
Sewage	○	○	○	○	○	○	○	○	○	○	○	○	○	○	○	○	○	○	○	○	○
Hot Water	●	●	●	●	●	○	○	○	○	○	○	○	○	○	○	○	○	○	○	○	○
Steam (<280°C)	●	●	●	●	○	○	○	○	○	○	○	○	○	○	○	○	○	○	○	○	○
Steam (<550°C)	○	○**	○** / ●	○	○	○	○	○	○	○	○	○	○	○	○	○	○	○	○	○	○
Abrasive Products	○	○	○	○	○	○	○	○	○	○	○	○	○	○	○	○	○	○	○	○	○
Food / Pharmaceutical	○	○	○	○	○	○	○	○	○	○	○	○	○	○	○	○	○	○	○	○	○
Oxygen	○	○	○	○	○	○	○	○	○	○	○	○	○	○	○	○	○	○	○	○	○
Diluted Acids	●	●	●	●	●***	○	○	○	○	○	○	○	○	○	○	○	○	○	○	○	○
Concentrated Acids	○	○	○	○	○	○	○	○	○	○	○	○	○	○	○	○	○	○	○	○	○
Diluted Alkaline, Salt Solutions	●	●	●	●	●	○	○	○	○	○	○	○	○	○	○	○	○	○	○	○	○
Concentrated Alkaline	○	○	○	○	○	○	○	○	○	○	○	○	○	○	○	○	○	○	○	○	○
Heat Transfer Oil	○	○	○	○	○	○	○	○	○	○	○	○	○	○	○	○	○	○	○	○	○
Lubricants, Grease	○	○	○	○	○	○	○	○	○	○	○	○	○	○	○	○	○	○	○	○	○
Solvent, Hydrocarbons	○	○	○	○	○	○	○	○	○	○	○	○	○	○	○	○	○	○	○	○	○
Adhesive, Bitumen	○	○	○	○	○	○	○	○	○	○	○	○	○	○	○	○	○	○	○	○	○
Paint	○	○	○	○	○	○	○	○	○	○	○	○	○	○	○	○	○	○	○	○	○

## Icon Key



Rotary



Reciprocating



Static



FDA Compliant

**Not all technical limits should appear at the same time.**

(\*) in steam conditionally  
○ - Alternative suggested

(\*\*) in combination with bullings of Style 310, 340 or 375  
● - Recommended

\*\*\* 7350X with BAM approval

# Mechanical Packing Installation



The successful installation of mechanical packing is a combination of common sense with easy to follow recommendations.

- 1) Remove **ALL** the old packing from the stuffing box.
- 2) Check the flush is working and has clean water.
- 3) Inspect the application and report any concerns to a higher authority (even at a later time) so that it can be logged.
- 4) Cut the selected packing using a sharp knife with one movement (don't saw through the packing). Use a proper packing cutting device.

**Table shows length in metres per 1 kg ( Displayed length may vary)**

AESSEAL® Packing Style	1/8"		3/16"		1/4"		5/16"		3/8"		7/16"		1/2"		9/16"		5/8"		3/4"		7/8"		1"		Inch
	density	3.2	4	5	6	6.4	7	8	9.5	10	11	12	12.7	14	15	16	18	19	20	22	25	25	mm		
335	1.0	98	63	40.0	27.8	24.8	20.4	15.6	11.1	10.0	8.3	6.9	6.2	5.10	4.44	3.91	3.09	2.77	2.50	2.07	1.60				
310, 366TP, 375	1.1	89	57	36.4	25.3	22.5	18.6	14.2	10.1	9.1	7.5	6.3	5.6	4.64	4.04	3.55	2.81	2.52	2.27	1.88	1.45				
325, 340	1.15	85	54	34.8	24.2	21.6	17.7	13.6	9.6	8.7	7.2	6.0	5.4	4.44	3.86	3.40	2.68	2.41	2.17	1.80	1.39				
245, 250TP, 350	1.2	81	52	33.3	23.1	20.7	17.0	13.0	9.2	8.3	6.9	5.8	5.2	4.25	3.70	3.26	2.57	2.31	2.08	1.72	1.33				
355	1.25	78	50	32.0	22.2	19.8	16.3	12.5	8.9	8.0	6.6	5.6	5.0	4.08	3.56	3.13	2.47	2.22	2.00	1.65	1.28				
210	1.3	75	48	30.8	21.4	19.1	15.7	12.0	8.5	7.7	6.4	5.3	4.8	3.92	3.42	3.01	2.37	2.13	1.92	1.59	1.23				
285TP, 290, 550, 760	1.35	72	46	29.6	20.6	18.4	15.1	11.6	8.2	7.4	6.1	5.1	4.6	3.78	3.29	2.89	2.29	2.05	1.85	1.53	1.19				
260, 330, 380TP, 870, 799	1.45	67	43	27.6	19.2	17.1	14.1	10.8	7.6	6.9	5.7	4.79	4.28	3.52	3.07	2.69	2.13	1.91	1.72	1.42	1.10				
270, 274, 275TP	1.50	65	42	26.7	18.5	16.5	13.6	10.4	7.4	6.7	5.5	4.63	4.13	3.40	2.96	2.60	2.06	1.85	1.67	1.38	1.07				
266TP, 785, 787, 795TP	1.55	63	40	25.8	17.9	16.0	13.2	10.1	7.1	6.5	5.3	4.48	4.00	3.29	2.87	2.52	1.99	1.79	1.61	1.33	1.03				
730, 7350X	1.6	61	39	25.0	17.4	15.5	12.8	9.8	6.9	6.3	5.2	4.34	3.88	3.19	2.78	2.44	1.93	1.73	1.56	1.29	1.00				
720, 745TP, 770TP, 790	1.70	57	37	23.5	16.3	14.6	12.0	9.2	6.5	5.9	4.9	4.08	3.65	3.00	2.61	2.30	1.82	1.63	1.47	1.22	0.94				

## Types of Cut

- Pumps and Mixers (Rotary):** We recommend butt cut, if a skive cut is chosen the ring should be precompressed in a die form.
- Butt Cut Rings:** Cut at approx 75 degrees. Add extralength in % to circumferential middle line according to the chart.
- Cutlength:**  $((D - d/2) + d) \times 3,14 \times (1.04 \text{ to } 1.09)$
- Valves (Static):** We recommend skive cut, exception fraying packing styles which are preferably cut butt.
- Skive Cut Rings:** Cut at 45 degrees on circumferential middle line and add 2%.

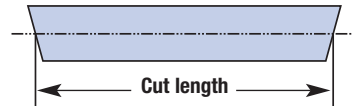

Shaft diameter	Add
up to 50mm / 2"	9%
51 to 100mm / 2" to 4"	7%
101 to 200mm / 4" to 8"	5%
201mm / 8" plus	4%

- 5) Tamp down each ring of packing with a suitable tool; do not rely on being able to tamp down all the rings within the gland as it is not possible. If a ring is a tight cross-sectional fit, do not tap it with a hammer to reduce its cross-section as this can damage the fibres. Instead, gently roll it with a round item.
- 6) Position: Rotate joints symmetric distributed ring to ring to eliminate any leak path. Tighten the gland with the nuts equally and then slacken off the nuts to relax the gland (Step A and B) before start up.
- 7) **Installation of Valve Packing:** Pre-compress the packing for pressures up to 50 bar (725 psi) with about 2 times (gaseous liquids up to 5 times) the pressure and a minimum of 5 N/mm<sup>2</sup>/725 psi (gaseous 10 N/mm<sup>2</sup>/1.450 psi) above 50 bar (725 psi) with 1.5 times (gaseous products up to 2 times) the pressure.  
**Installation of Pump Packing:** Adjust the nuts only finger tight (Step C), checking where possible that you can rotate the shaft by hand.
- 8) Turn on the flush (if used).
- 9) Start up the equipment.
- 10) Leave pump operating for 20 minutes before making any adjustments. Tighten as required by one flat of the nuts at 10 minute intervals until acceptable leakage is achieved (Step D).

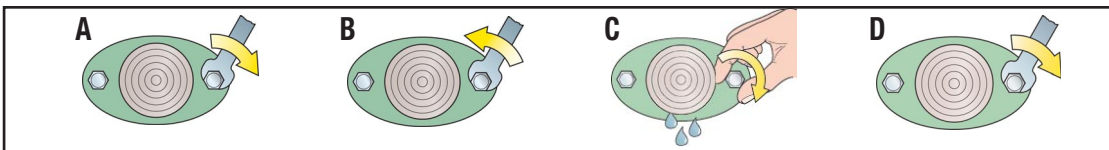

**Never** - Over tighten the gland nuts. If the gland is too tight, the fluid film between shaft and packing can be destroyed and packing life reduced.

**Never** - Back-off (slacken) the gland nuts under pressure!

Backing-off the gland nuts can allow hydraulic force from the product to push back the packing. Force from the gland follower cannot overcome the hydraulic force, and the integrity at the base of the stuffing box will be destroyed. The position of the lantern ring may also be affected and this may cut off the flush water.

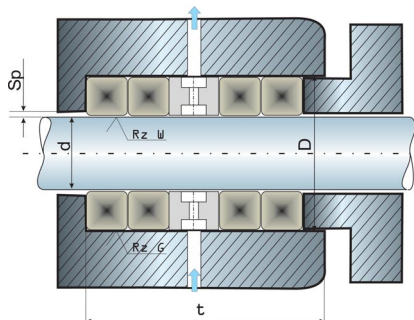

## Stuffing Box Design

### Standard Construction

- d = Pump shaft/Valve stem size
- D = Stuffing box bore
- T = Stuffing box depth
- Sp = Gap width
- Rz = Surface roughness

Shaft 1 to 5 µm  
Housing 6-16 µm

To avoid extrusion, the gap between shaft and housing, or between shaft and packing gland, should not exceed 2% of the packing size for higher pressure valve applications and 5% of packing size for lower pressure pump applications.



ENVIRONMENTAL TECHNOLOGY

**Our Purpose** 'To give our customers such exceptional service that they need never consider alternative sources of supply.'

	AESSEAL plc, Rotherham, UK	Tel: +44 (0) 1709 369966	rotherham@aesseal.com
	AESSEAL plc, Derby, UK	Tel: +44 (0) 1332 366738	derby@aesseal.co.uk
	AESSEAL plc, Peterborough, UK	Tel: +44 (0) 1733 230787	peterborough@aesseal.co.uk
	AESSEAL plc, Hamilton, UK	Tel: +44 (0) 1698 540422	scotland@aesseal.co.uk
	AESSEAL plc, Middlesbrough, UK	Tel: +44 (0) 1642 245744	northeast@aesseal.co.uk
	AESSEAL plc, Upminster, UK	Tel: +44 (0) 1708 256600	se@aesseal.co.uk
	AESSEAL plc, Pontypridd, UK	Tel: +44 (0) 1443 844330	ponty@aesseal.co.uk
	AESSEAL (MCK) Ltd, Lisburn, UK	Tel: +44 (0) 28 9266 9966	salesmck@aesseal.co.uk
	AESSEAL Ireland Ltd, Lisburn, UK	Tel: +44 (0) 28 9266 9966	sales.ireland@aesseal.co.uk
	AESSEAL Ireland Ltd, Co Cork, Eire	Tel: +353 (0) 214 633477	sales.ireland@aesseal.com
	AESSEAL Inc, Rockford, TN, USA	Tel: +1 865 531 0192	usa@aesseal.com
	AESSEAL Inc, Kingsport, TN, USA	Tel: +1 423 224 7682	kportadmin@aesseal.com
	AESSEAL Midwest Inc, Marion, IA, USA	Tel: +1 319 377 0170	midwest@aesseal.com
	AESSEAL Inc, NE, Fairfield, ME, USA	Tel: +1 207 453 6915	neadmin@aesseal.com
	AESSEAL Inc, NW, Longview, WA, USA	Tel: +1 360 414 0118	nwadmin@aesseal.com
	AESSEAL ALAA, Jubail, Saudi Arabia	Tel: +966 3 361 7461	sales.aesseal@afi.com.sa
	AESSEAL Argentina SA, Buenos Aires, Argentina	Tel: +54 11 4744 0022	aesseal@aesseal.com.ar
	AESSEAL Australia Pty Ltd, Seventeen Mile Rocks, Australia	Tel: +61 7 32791144	customer.service@aesseal.net.au
	AESSEAL Benelux BV, Breda, Holland	Tel: +31 (0) 76 564 9292	seal@aesseal.nl
	AESSEAL Brasil Ltda, São Paulo, Brazil	Tel: +55 11 5891 5878	aessealbrasil@aesseal.com.br
	AESSEAL Canada Inc, Vancouver, Canada	Tel: +1 604 535 7512	vanadmin@aesseal.com
	AESSEAL Chile SA, Providencia Santiago, Chile	Tel: +56 2 2343022	aesseal@aesseal.cl
	AESSEAL China Ltd, Ningbo, China	Tel: +86 (0) 574 8823 2888	service@aesseal.com.cn
	AESSEAL Colombia S.A., Bogota, Colombia	Tel: +57 (1) 634 9095	info@aesseal.com.co
	AESSEAL Czech sro, Brno, Czech Republic	Tel: +420 543 212 489	aesseal@aesseal.cz
	AESSEAL Danmark, A/S, Køge, Denmark	Tel: +45 56 64 14 00	mail@aesseal.dk
	AESSEAL Deutschland AG, Bad Orb, Germany	Tel: +49 (0) 6052 918810	info@aesseal.de
	AESSEAL Deutschland GmbH, Kronau, Germany	Tel: +49 (0) 7253 8090	gmbh@aesseal.de
	AESSEAL Finland OY, Muurame, Finland	Tel: +358 1433 84500	aesseal@aesseal.fi
	AESSEAL France SARL, Nieppe, France	Tel: +33 320 172850	aes.info@aesseal.fr
	AESSEAL India Pvt. Ltd, Pune, India.	Tel: +91 2113 302222	aesseal@aesseal.in
	AESSEAL India Pvt. Ltd, Hyderabad, India.	Tel: +91 40 2309 2999	indiainfo@aesseal.in
	AESSEAL India Pvt. Ltd, Chennai, India.	Tel: +91 44 2481 7786	chennai@aesseal.in
	AESSEAL India Pvt. Ltd, Visakhapatnam, India.	Tel: +91 891 2792 722	vizag@aesseal.in
	AESSEAL Coldweld Pvt. Ltd, Vasai (East), Thane, India.	Tel: +91 0250 2453220	mail@aescoldweld.com
	AESSEAL Italia SRL, Gallarate, Italy	Tel: +39 0331 799 952	info@aesseal.it
	AESSEAL Malaysia, SDN BHD, Selangor, Malaysia	Tel: +603 806 21233	selangor@aesseal.com.my
	AESSEAL Malaysia, SDN BHD, Pahang, Malaysia	Tel: +609 583 6133	kuantan@aesseal.com.my
	AESSEAL Malaysia, SDN BHD, Johor, Malaysia	Tel: +607 388 8323	johor@aesseal.com.my
	AESSEAL Mexico, S de RL de CV, Mexico City, Mexico	Tel: +52 833 226 9551	info-support@aessealmx.com
	AESSEAL Norway AS, Oslo, Norway	Tel: +47 2273 6849	aesseal@aesseal.no
	AESSEAL Polska, SP ZO.O, Bielsko Biala, Poland	Tel: +48 33 818 4135	aesseal@aesseal.com.pl
	AESSEAL Univeda LDA, Lisbon, Portugal	Tel: +351 217 969212	geral@aesseal.pt
	AESSEAL Russia, Koroliiov City, Moscow, Russia	Tel: +7 495 777 4011	aesseal@podlipki.ru
	AESSEAL Pty Ltd, Durban, South Africa	Tel: +27 (0) 31 903 5438	durban@aesseal.co.za
	AESSEAL Pty Ltd, Johannesburg, South Africa	Tel: +27 (0) 11 466 6500	admin@aesseal.co.za
	AESSEAL Ibérica SL, Tarragona, Spain	Tel: +34 977 55 43 30	info@aesseal.es
	AESSEAL Sweden AB, Stockholm, Sweden	Tel: +46 (0) 8 55602870	kundservice@aesseal.se
	AESSEAL Vo Lee Ltd, Kaohsiung County, Taiwan	Tel: +886 7 371 3990	info@aesseal.com.tw
	AESSEAL Turkiye, Istanbul, Turkey	Tel: +90 (0) 216 304 0237	info@aesseal.com.tr
	AESSEAL Uruguay, Montevideo, Uruguay	Tel: +598 2 924 7252	sealtecpic@aesseal.com.uy